



NanoQuest

MEMS-Based FT-IR Sensor

Installation and Operation Manual



For Product: NANOQ-2.5

Locations

Americas

Ocean Insight, Inc.

8060 Bryan Dairy Rd., Largo, FL 33777, USA

Manufacturing & Logistics

4301 Metric Dr., Winter Park, FL 32792, USA

Sales: info@oceaninsight.com

Orders: orders@oceaninsight.com

Support: techsupport@oceaninsight.com

Phone: +1 727.733.2447

Fax: +1 727.733.3962

Europe, Middle East & Africa

Sales & Support

Geograaf 24, 6921 EW Duiven, The Netherlands

Manufacturing & Logistics

Maybaachstrasse 11, 73760 Ostfildern, Germany

Email: info@oceaninsight.eu

Netherlands: +31 26-319-0500

Netherlands Fax: +31 26-319-0505

Germany: +49 711-341696-0

UK: +44 1865-819922

France: +33 442-386-588

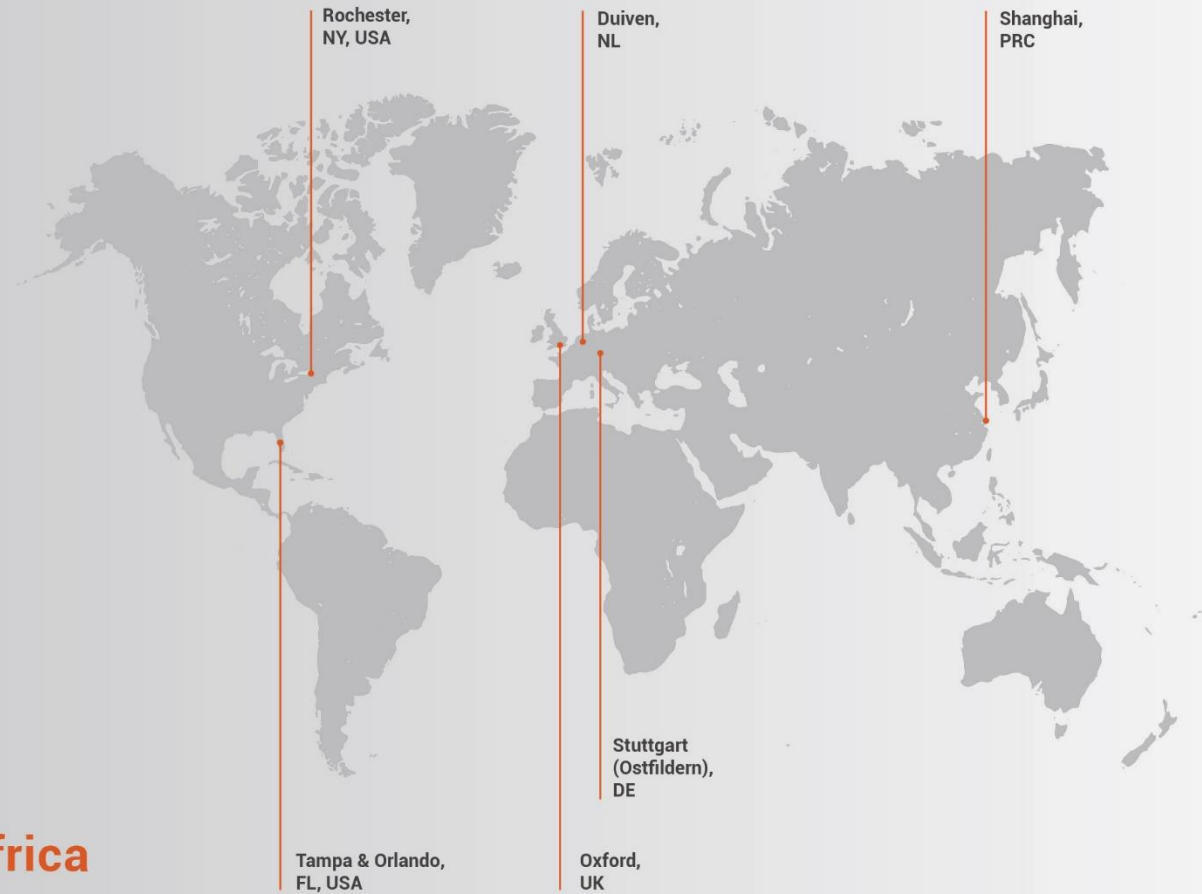

Asia

Ocean Insight Asia

666 Gubei Rd., Kirin Tower Suite 601B
Changning District, Shanghai, PRC, 200336

Email: asiasales@oceaninsight.com

China: +86 21-6295-6600

China Fax: +86 21-6295-6708

Japan & Korea: +82 10-8514-3797

www.oceaninsight.com

Table of Contents

About This Manual	ii	NanoQuest Software	15
Cautions	ii	Installation	15
Warranty.....	iii	Description of the GUI.....	16
Certifications and Compliance.....	iii	Recommended Setups	19
Product Overview	5	Transmission/Absorbance Measurements	19
NanoQuest Technology	5	Diffuse Reflection Measurements	21
Working principle.....	5	Advanced Settings	24
Measurement Steps	7	Troubleshooting	30
Interfaces	8	System Performance	30
System Requirements.....	8	Software.....	31
Environmental Conditions	9	References	32
Warm-up.....	9	Specifications	33
Mechanical Drawing.....	10		
Performance Optimization	11		
Measurement Parameters.....	11		
Advanced Settings	12		

Copyright © 2020 Ocean Insight

All rights reserved. No part of this publication may be reproduced, stored in a retrieval system, or transmitted, by any means, electronic, mechanical, photocopying, recording, or otherwise, without written permission from Ocean Insight.

This manual is sold as part of an order and subject to the condition that it shall not, by way of trade or otherwise, be lent, re-sold, hired out or otherwise circulated without the prior consent of Ocean Insight, Inc. in any form of binding or cover other than that in which it is published.

Trademarks

All products and services herein are the trademarks, service marks, registered trademarks or registered service marks of their respective owners.

Limit of Liability

Every effort has been made to make this manual as complete and as accurate as possible, but no warranty or fitness is implied. The information provided is on an “as is” basis. Ocean Insight shall have neither liability nor responsibility to any person or entity with respect to any loss or damages arising from the information contained in this manual

About This Manual

Cautions

Caution: Do not let contaminants get into the bench. Keep the protective cap on the slit aperture when not connected to an accessory, probe or fiber.

Caution: Do not immerse the device in any fluid, place fluids on top of or attempt to clean with liquid detergents or cleaning agents. This may cause an electrical hazard. Do not use if accidental wetting occurs.

Caution: Consult local codes and ordinances for proper disposal of equipment and other consumable goods.

Caution: Do not use if device is dropped and/or damaged. Have an authorized service representative check the device before using again.

Caution: Be sure to install any software BEFORE connecting the spectrometer to your PC or host system. The software installs the drivers required for spectrometer installation. If you do not install the software first, the system may not properly recognize the spectrometer.

Caution: The user of this spectrometer shall have the sole responsibility for any malfunction which results from improper use, faulty maintenance, improper repair, damage or alteration by anyone other than Ocean Insight or their authorized service personnel.

Caution: Do not apply excessive vibration or shock to the device. Although vibration rejection mode is supported, excessive vibrations may damage the unit.

Caution: Do not use organic solvents in cleaning. Wipe with a dry and clean tissue.

Caution: When attempting to connect the fiber, do not apply excessive force to the optical connector. Excessive force may damage the connector and will affect measurement results.

Warranty

For the most current warranty information, please visit OceanInsight.com.

Certifications and Compliance

Warning



The authority to operate this equipment is conditioned by the requirement that no modifications will be made to the equipment unless the changes or modifications are expressly approved by the manufacturer.



WEEE Compliance

The WEEE symbol on the product indicates that the product must not be disposed of with normal household waste. Instead, such marked waste equipment must be disposed of by arranging to return to a designated collection point for the recycling of waste electrical and electronic equipment. Separating and recycling this waste equipment at the time of disposal will help to conserve natural resources and ensure that the equipment is recycled in a manner that protects human health and the environment



This device has been tested and complies with the following standards:

EMC Directive 2014/30/EU

EN 61326-1:2013

ISO Certification

Ocean Insight, the industry leader in miniature photonics, has been certified for ISO 9001:2015 certification applicable to the design and manufacture of electro-optical equipment.

Product Overview

NanoQuest is a spectral sensing module whose working principle is based on the standard Fourier Transform Infrared (FT-IR) spectroscopy technique commonly used in conventional spectrometers. The core engine of FT-IR spectrometers is a Michelson interferometer. In NanoQuest, the whole Michelson interferometer is integrated on a single silicon chip.

NanoQuest Technology

NanoQuest determines the spectral content of the input light in the NIR wavelength range from 1350 – 2500 nm (7400 – 4000 cm^{-1}). The input light is either transmitted through a sample material or reflected from it using external sampling accessories. Post-analysis of the output spectra delivers the same functionality as standard benchtop FT-IR spectrometers: quantification, qualification, or identification of materials.

NOTE

Post-analysis of the measured spectra can be done using an advanced analysis software like [Analyze IQ Chemistry Software](#) or by working with our [Ocean Intelligence Machine Learning Software Team](#). Post-analysis software is not provided with the NanoQuest package.

Fourier Transform Infrared (FT-IR) Spectroscopy

The core of any FT-IR spectrometer is a two-beam optical interferometer named the Michelson interferometer. The basic block diagram of a Michelson interferometer's discrete components is shown below.

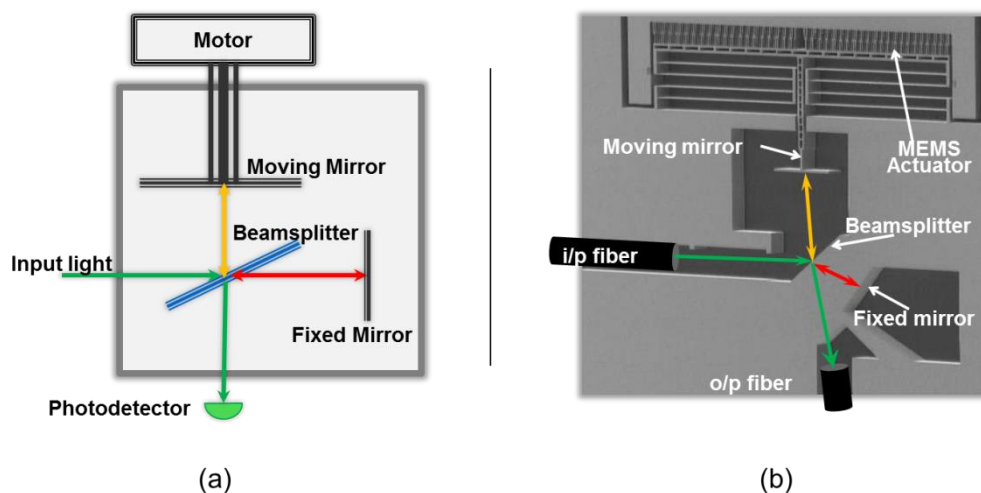

A beamsplitter splits the incident beam into two paths: one of the beams is reflected by a moving mirror, and the other is used as a reference when reflected by a fixed mirror. The moving mirror controls the Optical Path Difference (*OPD*) between the two reflected beams, which interfere to produce a pattern that corresponds to the spectral content of the input light. The latter is captured by the single photodetector generating an interferogram. The spectrum of the input light is directly generated by applying a Fourier Transform to the interferogram.

Measurement Steps

The spectrum (**S**) of a sample is given by the ratio of the spectrum of the beam transmitted or reflected from the sample (**I**) to the spectrum of the beam at the front face of the sample (**I_o**) over the spectral range of interest

$$S_{(\lambda_1 \rightarrow \lambda_2)} = \frac{I_{(\lambda_1 \rightarrow \lambda_2)}}{I_{o(\lambda_1 \rightarrow \lambda_2)}}$$

To measure the sample's spectrum (**S**), the background spectrum should be measured (**I_o**) (background measurement), as well as the light transmitted or reflected from the sample (**I**) (sample measurement). The NanoQuest software enables the acquisition of the background measurement and stores it to be used as a reference spectrum in further sample measurements.

It is recommended that the background spectrum be measured as frequently as possible, and ideally before each sample measurement. This ensures the most accurate results from the device.

Transmission Measurements

The background measurement **I_o** is obtained by measuring the spectrum of the transmitted beam without placing any material in the light path (e.g. an empty cuvette), under the same conditions at which the measurement of the sample will be conducted. Once the background measurement has been made, the sample measurement **I** is made by placing the sample in the sample holder.

Reflection Measurements

The background measurement (**I_o**) is obtained by measuring the spectrum of the reflected beam from an appropriate reflection reference standard with nearly flat spectral response across the spectral range of interest under the same conditions at which the measurement of the sample will be conducted. The sample spectrum (**I**) is then obtained by measuring the beam reflected from the sample.

Interfaces

- Optical interface: light can be coupled to NanoQuest via an optical fiber with standard FC-PC connector
- Data and power interface: communication with NanoQuest is established through USB 2.0 interface. NanoQuest has a Mini-B receptacle USB connector for the interface with other devices. The USB connector is also used to supply NanoQuest with its required power for operation.

System Requirements

Parameter	Requirements
Operating systems	Microsoft Windows 7 (both x86 and x64) Microsoft Windows 8 (both x86 and x64) Microsoft Windows 10 (both x86 and x64) Ubuntu 12.04 (both x86 and x64) Debian 32 bit (ARM architecture)
CPU Specs	Processor: Core 2 Duo, 2 GHz or higher RAM: 2 GB or higher

Environmental Conditions

The NanoQuest should be kept in environments that maintain the temperature conditions listed below.

Parameter	Value	Units
Operating temperature	-5 – +40	°C
Storage temperature	-20 - +85	°C

Warm-up

Upon connecting the NanoQuest to the PC via USB, the system takes 15 to 20 minutes to become thermally stabilized. The module is operational during warm-up. However, repetitive measurements of the same sample while the unit is warming up may lead to slightly different spectra. If measurements are to be taken during warm-up time, it is recommended to make a background measurement right before each sample measurement.

Mechanical Drawing

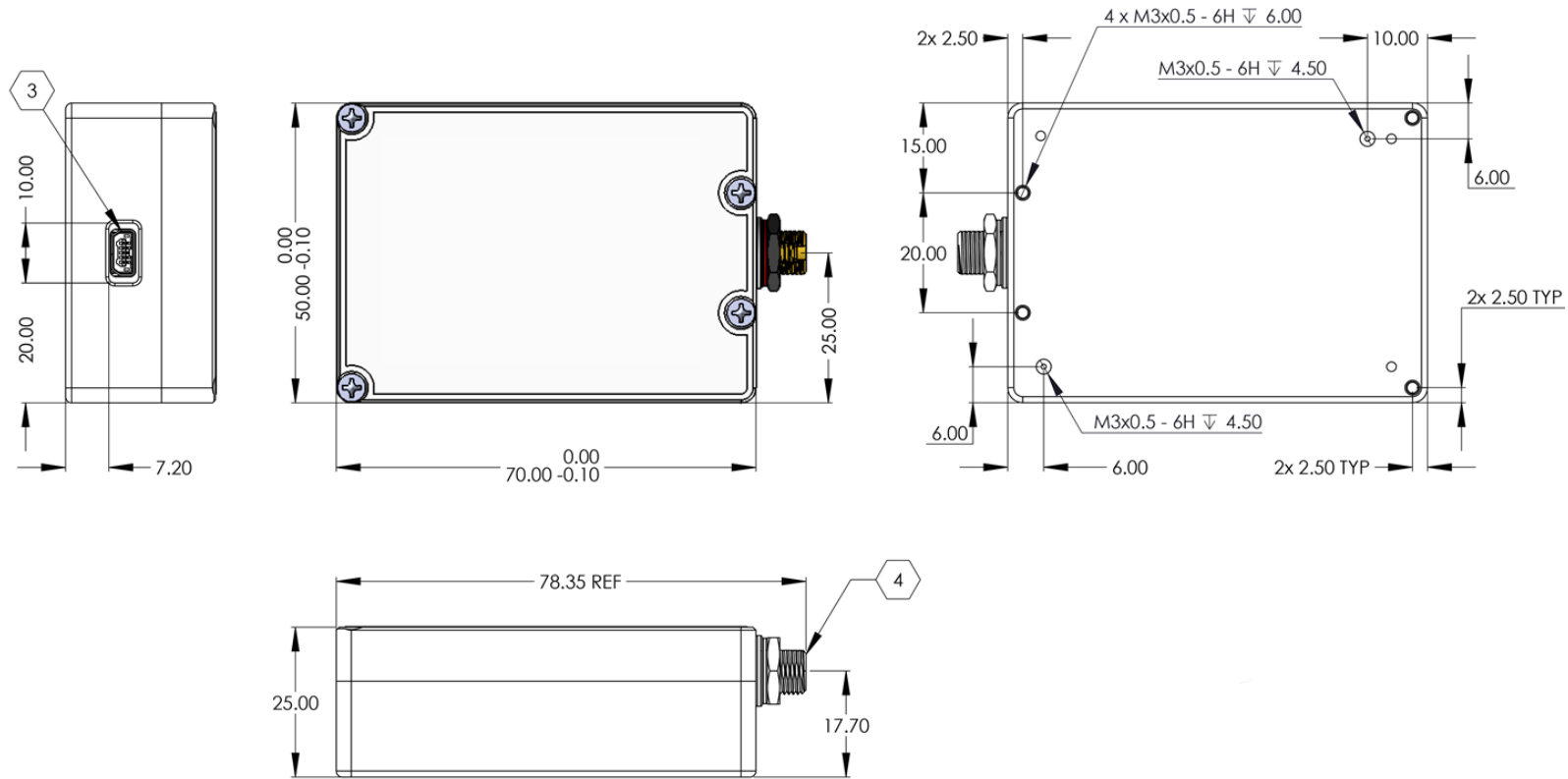

Performance Optimization

The performance of spectral sensors is commonly characterized by different parameters that are usually interdependent. The software enables optimization of performance by allowing a set of values for some parameters to be changed and certain hardware settings to be adjusted.

This chapter describes the effect of the different parameters on the Signal to Noise Ratio (SNR), as well as some advanced settings that can be used to optimize the overall performance of the system.

Measurement Parameters

NanoQuest is based on FT-IR, so the dependencies between the different performance parameters are governed by the same relationships as conventional FT-IR systems. Scan time and resolution are two parameters that can be set with the software to optimize the performance of the system depending on target requirements. In this section, we summarize the main elements that need to be considered when adjusting these two parameters.

Scan Time

Scan time is defined as the time taken by the interferometer to scan the input light signal. Higher scan time implies higher number of scan cycles to be averaged, hence higher SNR.

The scan time can be adjusted by setting a value higher than 10 ms.

The Signal to Noise Ratio (**SNR**) of the system is directly proportional to the square root of the scan time (t_s) [$SNR \propto \sqrt{t_s}$] [1].

Resolution

There are several definitions for resolution. In FT-IR, nominal resolution is often defined as the reciprocal of the maximum OPD. Practically, resolution is defined as the minimum spacing between two consecutive wavelength ($\Delta\lambda$) / wavenumber ($\Delta\nu$) points that can be fully resolved. Two neighboring spectral features of equal height and width are said to be resolved if there is a dip of at least 20% between the two maxima.

The Signal to Noise Ratio (SNR) of the system is directly proportional to resolution ($\Delta\nu$) [$SNR \propto \Delta\nu$] [1].

Advanced Settings

Gain Settings

The NanoQuest module has an internal Analog to Digital Converter (ADC) that converts the interferogram data (analog current detected by the photodetector) to a digital signal.

NanoQuest has two main gain settings:

- **Transmission:** optimum gain setting corresponding to the coupled power in a typical transmission setup.
- **Reflection:** optimum gain setting corresponding to the coupled power equivalent of 1/32 of the coupled power in a typical transmission setup.

The conversion ratio can be adjusted to:

1. Avoid saturation of the amplifiers: saturation leads to signal clipping and attenuation.
2. Enhance the SNR: using the **Transmission** gain option for diffuse Reflection measurements degrades the optimum SNR by a factor between 3-5 depending on the optical power coupled from the reflection setup.

Apodization

The interferogram can be multiplied by one of several different apodization functions to make a gradual decay to zero values at both sides of the interferogram, and hence to smooth the spectrum.

The process of apodization affects both the resolution and the noise level of FT-IR spectra:

- **Resolution:** the information near the interferogram's centerburst determines the shape of the single-beam spectrum, and this low-resolution spectrum is largely unchanged when the interferogram is multiplied by an apodization function. Conversely, the sinusoids of narrow spectral features take much longer to decay and are therefore far more attenuated when the spectral data are apodized, leading to degradation of resolution.
- **Noise:** lowspatial-frequency noise and very broad bands are also largely unaffected by apodization. Highspatial-frequency noise is attenuated on apodization. On the average, the root mean square (rms) noise on the spectrum is decreased on apodization and the SNR increases.

The specific apodization function that should be used for a certain application is chosen by experimentation [1].

Zero Padding

Spectra being measured on FT-IR spectrometers consist of intensity values at equally spaced intervals. The discrete nature of the data makes it highly unlikely that the maximum absorption of any band will correspond exactly with one of these data points. In addition, the slope of the spectrum can appear to change markedly from one point to the next. To eliminate these problems, some form of interpolation or alternative data processing is necessary. One of the most useful of these is zero padding (also known as Zero Filling).

Considering complex Fourier transformation of an interferogram that consists of N data points, the real and imaginary spectra each contain $N/2$ data points. Increasing the number of points by N (adding $N/2$ zeros to each end of the double-sided interferogram) increases the number of data points per resolution element to two. This process may be continued until the data point spacing in the calculated spectrum is so small that no information is lost visually [2].

Available options of zero padding are: 0,1,3,7 corresponding to

- 0: No zero padding is applied
- 1: N zeros are added to the interferogram
- 3: $3N$ zeros are added to the interferogram
- 7: $7N$ zeros are added to the interferogram

Wavenumber Correction

The wavelength/wavenumber axis of the measured spectrum can drift with aging. Two correction techniques are available:

1. Self-Correction: system is auto-corrected with a smart built-in algorithm. The auto-correction is done after measuring the background reference white light -- i.e., no sample in the light path.
2. Correction using Reference Material: the user can use a standard reference material to correct wavenumber drifts in NanoQuest. The user enters the reference absorption peak positions that correspond to the selected resolution (8 nm or 16 nm at wavelength 1,550 nm).

Wavelength/wavenumber correction should be applied regularly to maintain NanoQuest performance. Depending on the environment, wavelength/wavenumber correction can be performed every day, week, month or year. Details on how to perform wavenumber correction using the NanoQuest software is explained in the [Advanced Settings](#) section.

NanoQuest Software

NanoQuest Software enables plotting, saving, and loading measured spectra, as well as setting acquisition and data processing parameters for the NanoQuest.

Installation

1. Run the installation wizard.
2. The NanoQuest software is only available in English.
3. When the welcome screen appears, make sure that all other applications are closed, then click **Next**.
4. After the terms and conditions are read, click **Next** to proceed.
5. Browse to the installation directory then click **Next**.
6. Select the Start Menu folder in which the NanoQuest software shortcuts shall be created then click **Next**.
7. Check preferences to **Create a desktop icon** then click **Next**.
8. When the wizard is ready to install, click **Install** to proceed.
9. The installation wizard will detect if the appropriate JRE Version is already installed on the computer:
 - a. If it exists, installation wizard will proceed to Step 10.
 - b. If it does not already exist, a JRE installer will be launched automatically.
10. The installation wizard will start preparation of the installation process of the NanoQuest hardware drivers. A pop-up screen will give guidance for the remaining steps required to finish the installation procedure. This may require user permission for Windows Security. If the warning message "Windows can't verify the publisher of this driver software" appears, select the option **"Install this driver software anyway"** on Windows Vista, Windows 7 or Windows 10. Select **"Yes"** on Windows XP to proceed.
11. The software installation is complete.

Description of the GUI

1. Tabs selection:

- “Spectrum” tab: This tab is used to set acquisition parameters and display spectral data.
- “Interferogram & PSD” tab: This tab displays the measured interferogram and its corresponding Power Spectral Density (PSD)

2. Measurements Parameters area:

- Scan Time: User can specify the Scan Time for the measurements.
- Resolution: User can select between different pre-set resolution values.
- Optical Gain Settings: User can select the optical gain for different measurement types (Absorbance/Transmission or Reflection). The X button allows deleting a gain setting selected in the dropdown menu.
- Run Mode:
 - i. Single: Display the data for a single measurement at the specified scan time.
 - ii. Cont.: Take continuous consecutive measurements at the specified scan time.
- Command buttons:
 - i. Spectrum tab:
 1. Background: Initiate the background measurement. No material should be present in the light path during this measurement. For the best measurement results, background measurements should be taken as frequently as possible. A new background measurement must be taken when any measurement parameter is changed (e.g., Resolution, Optical Gain Settings, etc.).
 2. Run: Initiates the spectrum measurement for the sample placed in the light path. The background-corrected spectrum is automatically calculated and displayed.
 3. Stop: Cancels the current measurement in progress.

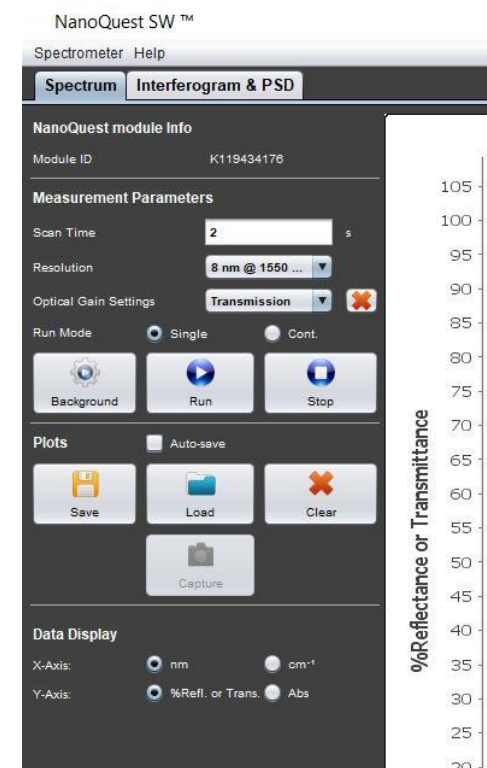

ii. Interferogram and PSD tab:

1. Run: Initiates measurement of the interferogram and the corresponding PSD.
2. Stop: Cancels the current measurement in progress.

3. Plots Graph Manipulation area:

- **Save:** Save all data sets (X- and Y-axis values of plotted graphs) shown in the display area. Files collected in the Spectrum tab will be saved with *.Spectrum extension. Data collected in the Interferogram & PSD tab will be saved with *.InterPSD and *.Interferogram extensions. This command allows the user to select a folder where all data sets are saved and specify a prefix which will be used with the measurement number, shown in the legend below the display area, to save the file.
- **Load:** User can load previously saved data in *.Spectrum, *.InterPSD or *.Interferogram formats.
- **Clear:** Clears all displayed data sets in the display area.
- **Capture:** Useful only in continuous run mode. Keeps the last plotted graph so it is not replaced by the next measurement.
- **Auto Save check box:** When enabled, automatically saves measured data.
 - i. Single run mode: Saves each plotted graph.
 - ii. Continuous run mode: Saves only the captured and the last plotted graphs.

4. Data Display area:

- **Spectrum tab:** Select units for the Y-axis of displayed data (either absorbance or percentage transmittance/reflectance). Select units for the X-axis of displayed data (either nm or cm^{-1}).
- **Interferogram & PSD tab:** Select units for the X-axis of displayed data (either nm or cm^{-1}).

5. Advanced Settings area:

Advanced settings are accessed by clicking Spectrometer | Advanced/FFT Settings from the top toolbar. Advanced Settings and FFT Settings menus will display below the Spectrum window.

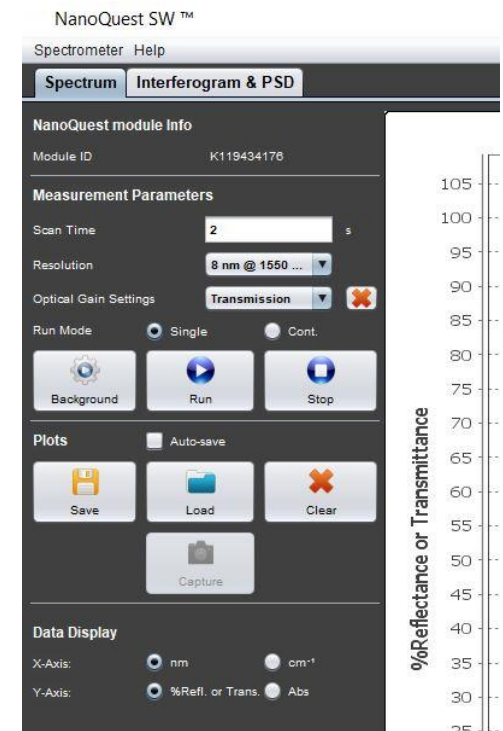

- Add Optical Gain Settings: Opens a wizard that enables the creation of new gain settings optimized for the optical power coupled into the NanoQuest. The gain settings are stored on the PC on which the measurement is being performed. The gain settings will not be transported when the module is used on another host unless the settings are burned into the NanoQuest.
- Wavelength/Wavenumber Correction: Opens a wizard that allows correction of wavelength/wavenumber errors caused by long term drift.
- Burn Settings: Opens a wizard that enables burning the advanced setting changes to the NanoQuest.
- Restore Default Settings: Reloads the default settings with which the module was delivered.

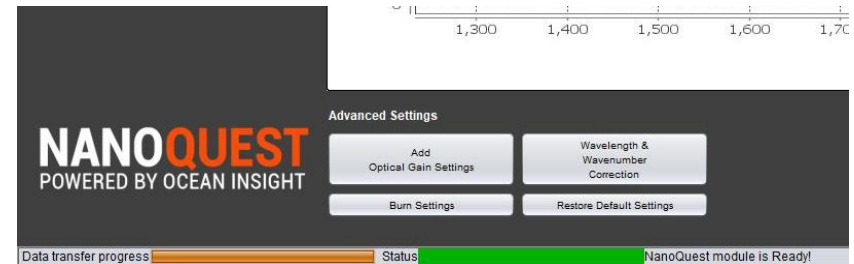

6. FFT Settings:

- Apodization: Select one of several filter techniques to apply to the displayed spectrum.
- Zero Padding: Select one of the zero padding options to smooth the displayed spectrum.
- Update Results: Apply the selected FFT Settings to the displayed spectrum.



Recommended Setups

Transmission/Absorbance Measurements

1. Initialize:
 - Start the NanoQuest software.
 - Connect the spectrometer module to the PC using the USB cable that came with the NanoQuest and wait for the module to initialize (i.e., the color of the status bar goes from yellow to green).
 - The software automatically detects the NanoQuest’s Spectrometer ID and sets the appropriate interfacing parameters.
2. Set measurement parameters:
 - Scan Time: Set the scan time that best fits your requirements. The higher the Scan Time, the higher the number of acquisitions averaged and the better the signal to noise ratio.
 - Resolution: Select either 8 or 16 nm optical resolution (FWHM).
 - Optical Gain Setting: Select Transmission or a user created custom gain setting.
 - Run Mode: Choose Single or Cont. to set spectral acquisition to stop after a single acquisition or to acquire data continuously until stopped.
3. Make the measurement:
 - With no sample in the light path, click the **Background** button and wait until the message **Background measurement completed successfully** appears in the message bar.
 - To measure the sample spectrum, place the sample material under test in the light path and click the **Run** button:
 - If operating in single mode: Wait until the data is displayed.

Component	Recommended Type
Light source	HL-2000-HP or HL-2000-HP-FHSA
Optical connection	<ul style="list-style-type: none"> • NANOQ-FIBER-400-VIS-NIR from NanoQuest to cuvette holder • QP400-1-VIS-NIR fiber from cuvette holder to light source
Sample holder	<ul style="list-style-type: none"> • SQUARE ONE cuvette holder • Quartz cuvettes
Electrical connection	USB cable
Host	PC

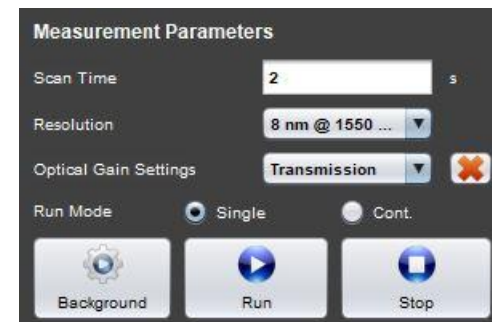

- If operating in continuous mode: The software will make consecutive measurements and automatically update the plotted data. Click **Capture** to capture a measured spectrum that is displayed on the screen or click **Stop** to stop acquisition of new spectra.

4. Post-measurement actions:

- Save plotted data (all plots in the **Spectrum display** will be saved).
- Load previously saved spectra.
- Plots are saved in a file with the extension **.spectrum**. They can be easily viewed in a text reader and converted to other readable formats.
- X-axis and Y-axis data units of displayed data can be changed based on user preference.



Diffuse Reflection Measurements

1. Initialize:

- Start the NanoQuest software.
- Connect the spectrometer module to the PC using the USB cable that came with the NanoQuest and wait for the module to initialize (i.e., the color of the status bar goes from yellow to green).
- The software automatically detects the NanoQuest's Spectrometer ID in use and sets the appropriate interfacing parameters.

2. Optimize the optical power coupling:

- Go to the Interferogram tab in the NanoQuest software.
- Adjust the acquisition parameters as described below:
 - Scan time: 100 ms (Short scan time is selected for high repetition rates of the measurements. The intent is not to have a high SNR in this step.)
 - Resolution: Select either 8 or 16 nm optical resolution (FWHM).
 - Optical gain settings: Select Reflection or a user created custom gain setting.
 - Run Mode: Continuous
- Place the probe in the probe holder.
- Place the reflection standard at the front face of the probe.
- Click **Run**.
- Monitor the interferogram and PSD plots during the continuous acquisition:
 - The plots will continue updating. Monitor the peak to peak value of the interferogram's centerburst while slightly adjusting the distance between the probe and reflection standard in the probe holder.

Component	Recommended Type
Light source	Halogen HL-2000-HP or HL-2000-HP-FHSA
Optical interface	<ul style="list-style-type: none"> • NANOQ-RPROBE-600-VIS-NIR • FC-terminated leg to NanoQuest • SMA-terminated leg to light source
Sample reference	Spectralon/ PTFE
Electrical connection	USB cable
Host	PC

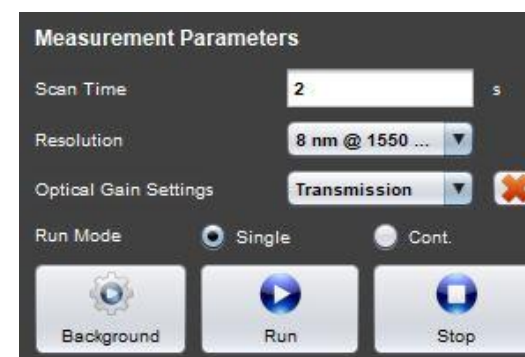

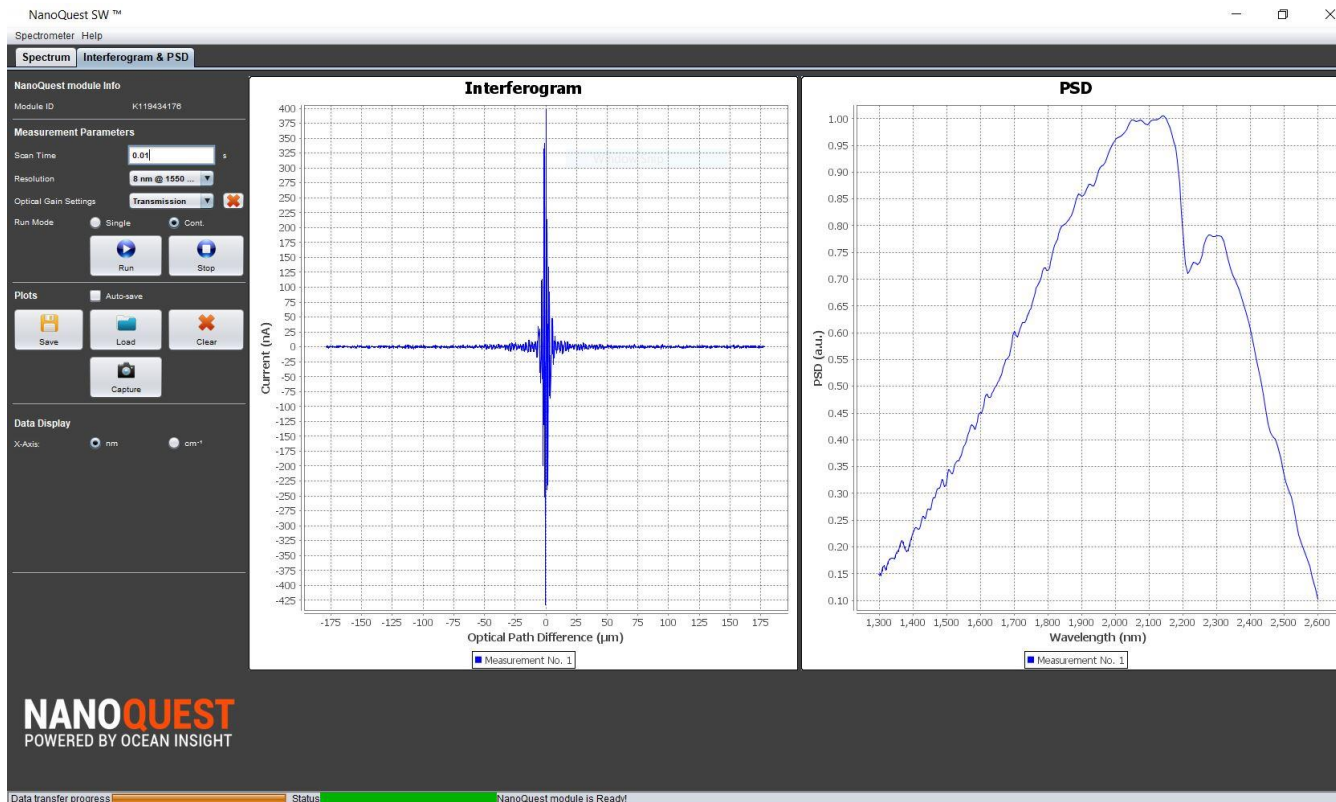

- Stop adjusting the distance at the point where the value of the peak to peak centerburst in the

interferogram and/or the PSD value are maximum and lock the probe in position. This is the optimum optical distance between the probe and reference/standard.

- Optional: Capture the plots and save them for future reference.
- Click **Stop**.
 3. Set measurement parameters:
 - Go to the Spectrum tab.
 - **Scan Time**: Set the scan time that best fits your requirements. The higher the Scan Time, the higher the number of acquisitions averaged and the better the signal to noise ratio.
 - **Resolution**: Select either 8 or 16 nm optical resolution (FWHM).

- Optical Gain Setting: Select Reflection or a user created custom gain setting.
 - Run mode: Choose Single or Cont. to set spectral acquisition to stop after a single acquisition or to acquire data continuously until stopped.
4. Make the measurement:
- With no sample in the light path, click the **Background** button and wait until the message **Background measurement completed successfully** appears in the message bar.
 - To measure the spectrum, place the sample material under test at the front face of the probe and click the **Run** button:
 - If operating in single mode, wait until the data is displayed.
 - If operating in continuous mode, the software will operate consecutive measurements and will automatically update the plotted data. Click **Capture** to capture a certain measured spectrum that is displayed on the screen or Click **Stop** to stop the acquisition of new spectra.
5. Post-measurement actions:
- Save plotted data (all visible plots will be saved).
 - Load previously saved plots.
 - Plots are saved in a file with an extension **.spectrum**. They can be easily viewed in a text reader converted to other readable formats.
 - X-axis and Y-axis data units of displayed data can be changed as preferred.

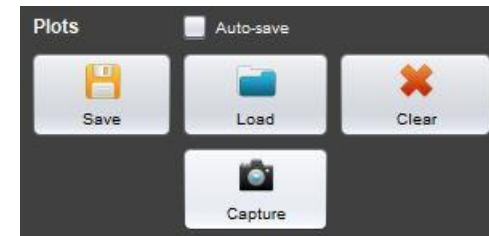

Advanced Settings

Advanced settings are accessed by clicking Spectrometer | Advanced/FFT Settings from the top toolbar. Advanced Settings and FFT Settings menus will display below the Spectrum window.

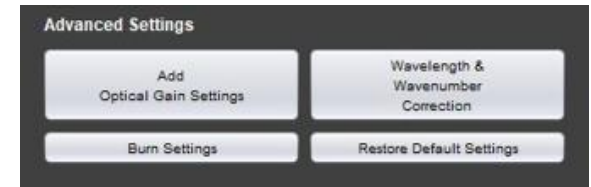

Managing Gain Settings

If the default gain settings are not adequate to the light source, the user can add a new gain setting. The following steps can be taken to manage the optical gain settings.

Create new optical gain settings

1. Click on **Add Optical Gain Settings** button to open the wizard.
2. In the wizard, type the name of the optical gain you would like to add in the **Setup Name** field.
3. Click on **Proceed>>** button.
4. A window will pop up asking you to connect the light source to the module. Connect the light source and press **OK**.
5. To save the settings press on the **Proceed>>** button.
6. A notification message will popup informing the user that the settings have been saved successfully.
7. Press the **OK** button. The setting should now be saved on the host.
8. The new optical gain setting should now appear in the **Optical Gain Settings** drop down list.

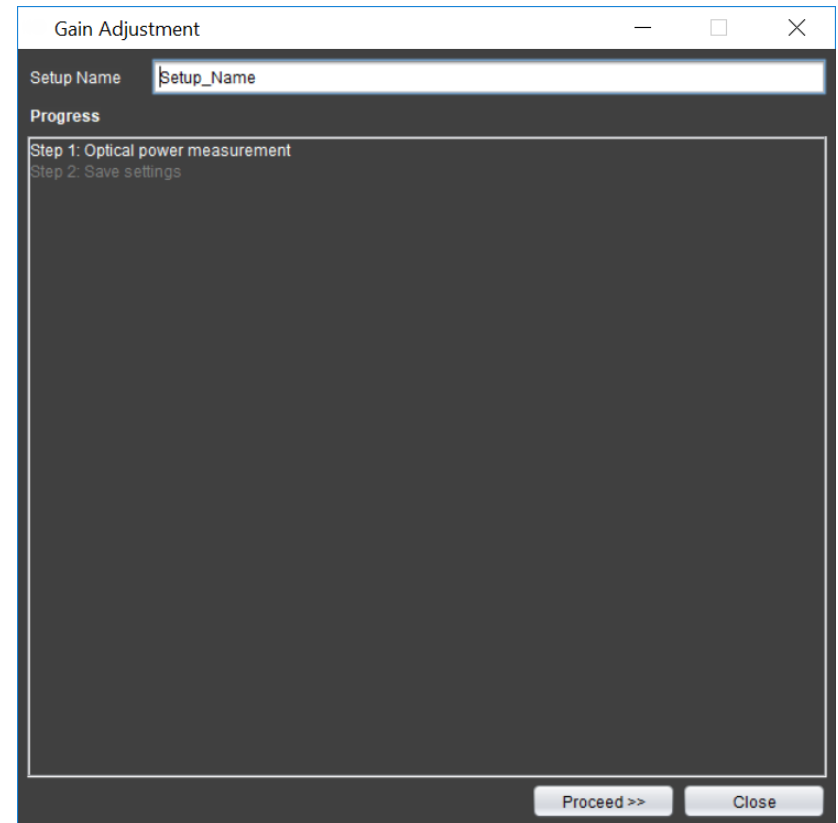

Deleting an optical gain setting

1. Select the optical gain setting you would like to delete from the **Optical Gain Settings** drop-down list.
2. Click on the red x next to the drop-down list.
3. A confirmation message will popup, click on the **Yes** button to proceed.

NOTE

If you connect the NanoQuestinuse to another computer, the newly created gain settings will not be available unless you burn these settings on the module.

Applying Wavelength Correction

In rare cases in which there appears to be a wavelength or wavenumber error, perform the wavelength/wavenumber correction. The software features two techniques for this correction.

Applying self-correction:

1. Click on the **Wavelength & Wavenumber Correction** button to open the wizard.
2. Select the **Self-Correction** radio button and click on the **Proceed>>** button.
3. A window will pop up asking you to connect the light source to the module. Connect a broadband NIR light source and click **OK**.
4. Wait until the auto-correction is done. A window will pop up at the end of the operation.
5. Click **OK**, then **Close** the wizard.

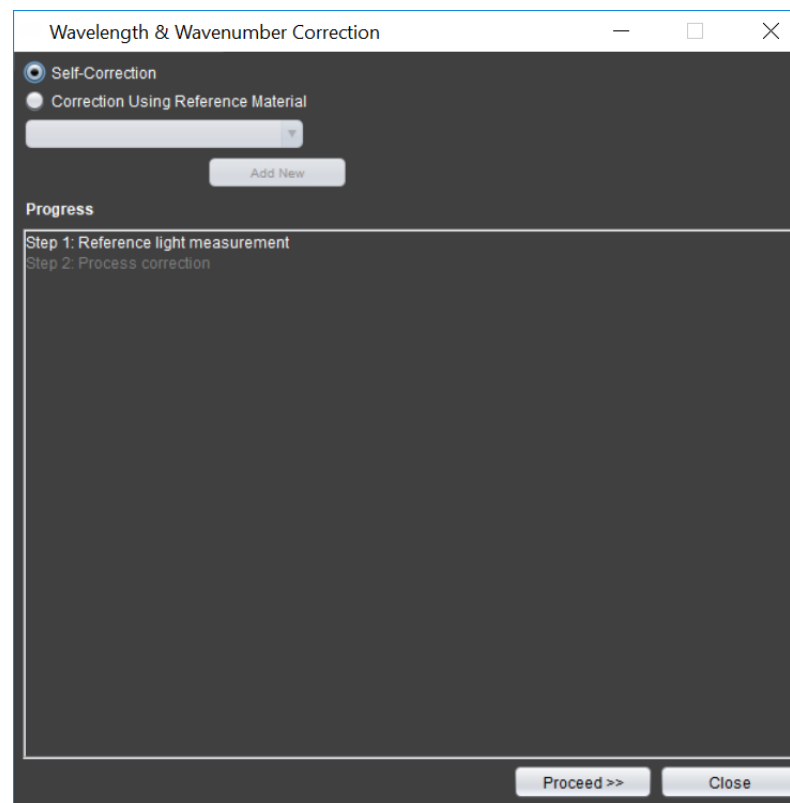
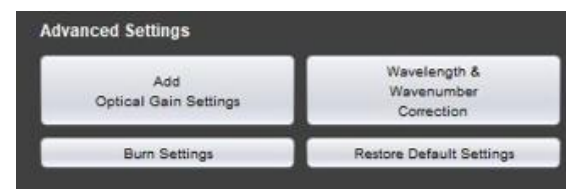

Applying correction using reference material

TS5 (proprietary organic matrix available from [Starna](#)) can be used as a reference material for wavelength correction [3]. NIR spectra for this material is pre-stored in the software. If you would like to apply the wavelength correction using this material, follow the steps below. The steps for adding a user-specified reference material are described in the next section.

Wavelength correction using reference material that already exists:

1. Click on the **Wavelength & Wavenumber Correction** button to open the wizard.
2. Select the **Correction Using Reference Material** radio button.
3. Select the material name from the drop-down list.
4. Click on the **Proceed>>** button.
5. A window will pop up asking you to connect the light source to the module. Connect the light source with no sample in the light path and click **OK**.
6. Wait until the measurement is processed. The step should be highlighted in green after the measurement is done.
7. Take a measurement with the TS5 reference material. To initiate this step, click on the **Proceed>>** button
8. A window will pop up asking you to insert the sample. Connect the light source with a sample in the light path and click **OK**.
9. Wait until the measurement is done. A window will pop up by the end of the operation.
10. Click on the **OK** button, then **Close** the wizard

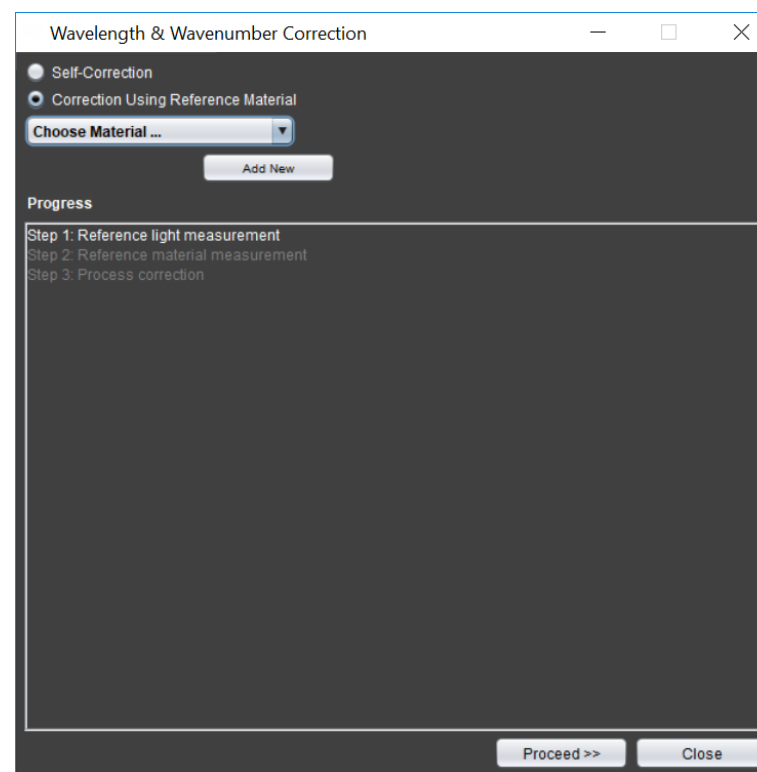

Creation of data for new reference material:

1. Click on the **Wavelength & Wavenumber Correction** button to open the wizard.
2. Select the **Correction Using Reference Material** radio button.

3. Click on the **Add New** button.
4. A new window will pop-up:
 - In the text box insert the name of the material and two distinctive wavelength points in nanometer units using the following format:
 - i. *Standard_Calibrator_Name* {<1st value in nm> , <2nd value in nm>}.
(For example: NewMaterial{1367.5,1417.5}).
 - The chosen wavelength values are the ones that the software will use for the wavelength correction.
5. Click **OK**.
6. If your entry is correct, a new window will popup stating the creation of the new reference has been completed. The newly created reference material should now appear in the dropdown menu.

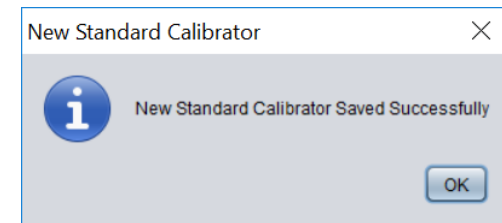
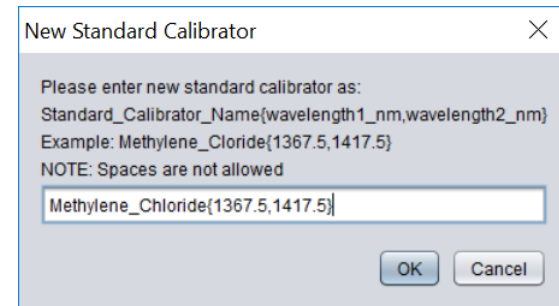

Burning Settings into the NanoQuest

The gain settings and wavelength correction will not be transported with the NanoQuest to another computer unless the new settings are burned into the NanoQuest. To burn custom optical gain settings and/or wavelength correction to the NanoQuest follow the steps below:

1. Click on the **Burn Settings** button.
2. In the wizard, select from the list of the optical gain settings that you would like to burn to the module. To select multiple settings, hold the **CTRL** button while clicking on the settings names.
3. Check the **Include Correction** checkbox, if needed.
4. Click on the **OK** button.

At any time, you can restore the module to factory settings by clicking on **Restore Default Settings**. You can choose which settings to restore from the dropdown menu of the wizard.

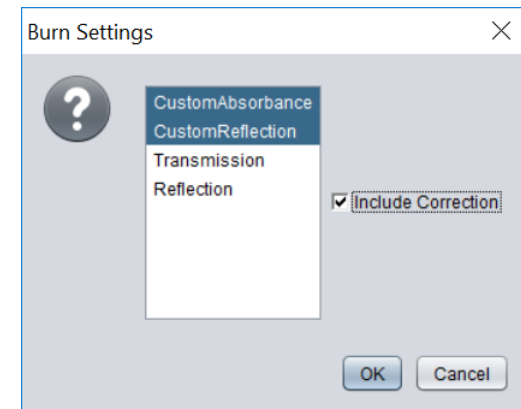

FFT Settings

FFT Settings consist of two parameters that are used by the software to convert the interferogram data into a spectrum: the Apodization function and number of Zero Padding points.

The selection of the apodization and zero padding options can be performed before or after the measurement by selecting these options from the drop-down menus:

- Select the Apodization option from the **Apodization drop-down**.
- Select the Zero Padding option from **Zero Padding drop-down**.
- Click the **Update Results** button.
- A new spectrum with the new FFT settings will be drawn in the display area.



Troubleshooting

If your questions are not answered in this section, please contact us at www.OceanInsight.com.

System Performance

Symptom	Possible Cause	Corrective Actions
Noise is at a high level	Insufficient optical power is coupled into the system	Make sure that the optical power is within the recommended range and make sure that all the components of the sampling setup are well positioned and intact.
	Optical gain settings are not well optimized	Make sure that you are using the correct optical gain settings and create new optical gain settings with your setup if you have not already done so.
	System is stabilizing	Make sure you have waited enough time for your light source to stabilize and more than 15 minutes for the NanoQuest module to stabilize.
The wavelength accuracy has declined	The module is operating outside the specified operating range	Make sure that the ambient temperature does not exceed 40 °C or go below -5 °C.
	Aging effect if operating in harsh environments	Perform wavelength calibration routines.
The baseline of the spectrum is shifted above or below 100%	Optical gain settings are not well optimized	Make sure that you are using the correct optical gain settings and create new optical gain settings with your setup if you have not already done so.
	Measurements are taken during the warm-up time of the light source	Make sure that measurements are taken after the stabilization of the light source. You may need to refer to the datasheet of the light source to know the typical warm-up time. If measurements are to be taken during the warm-up time, frequent background measurements are required.

	Background and/or sample measurements have been taken during NanoQuest warm-up.	Make sure that measurements are taken 15 – 20 minutes after connecting the module to the host. If the measurements are to be taken during the warm-up time, frequent background measurements are required.
Wavelength drifts, or baseline tilts are observed in the measured spectra	Background and/or sample measurements have been taken during the warm-up time of the module.	Make sure that measurements are taken 15 – 20 minutes after connecting the module to the host. If the measurements are to be taken during the warm-up time, frequent background measurements are required.

Software

Symptom	Possible Cause	Corrective Actions
The software does not detect the NanoQuest module although it is connected	Problem with the USB cable	Change the USB cable
	Driver is not properly installed	Check in the device manager that the USB driver is properly installed. You may need to manually remove the driver from the device manager and reinstall the software.

References

- [1] P. R. G. a. J. A. d. Haseth, *Fourier Transform Infrared Spectrometry*, New Jersey: John Wiley & Sons, Inc., 2007.
- [2] P. Griffiths, *Applied Spectroscopy*, vol. 29, pp. 11-14, 1975.
- [3] J. H. Christopher Burgess, "Wavelength standards for Near Infrared Spectral Region," *Spectroscopy online*, 2007.
- [4] E. W. C. Donal A. Burns, *Handbook of Near-Infrared Analysis*, CRC Press, 2008.
- [5] "E-1944: Standard Practice for Describing and Measuring Performance of Laboratory Fourier Transform Near-Infrared (FT-NIR) Spectrometers: Level Zero and Level One Tests," ASTM International.
- [6] "U.S. Pharmacopeia standard for Near Infrared Spectrometry," [Online]. Available: http://www.pharmacopeia.cn/v29240/usp29nf24s0_c11119.html. [Accessed July 2016].

Specifications

Parameters	Value	Condition
Wavelength Range	1,350 – 2,500 nm	PSD* > Max PSD/10
Wavelength Resolution	8 or 16 nm	@ λ = 1.55 μ m, FWHM criterion
SNR	>3000: 1 (@ λ =2,100 nm)	0.5 s scan time, Tx, Resolution: 16 nm
	1000: 1 (@ λ =2,100 nm)	2 s scan time, Rx, Resolution: 16 nm
Wavelength Accuracy	\pm 1.5 nm	@ λ = 1.4 μ m; Temperature <40 °C
Wavelength Repeatability	\pm 0.1 nm	@ λ = 1.4 μ m, absorbance level: 0.5 AU, , Resolution: 16 nm
Operating Temperature	-5 to 40°C	

Questions?

Chat with us at [OceanInsight.com](https://oceaninsight.com).

info@oceaninsight.com • **US** +1 727-733-2447

EUROPE +31 26-3190500 • **ASIA** +86 21-6295-6600